

### EMERGENCY LIGHTING INVERTER

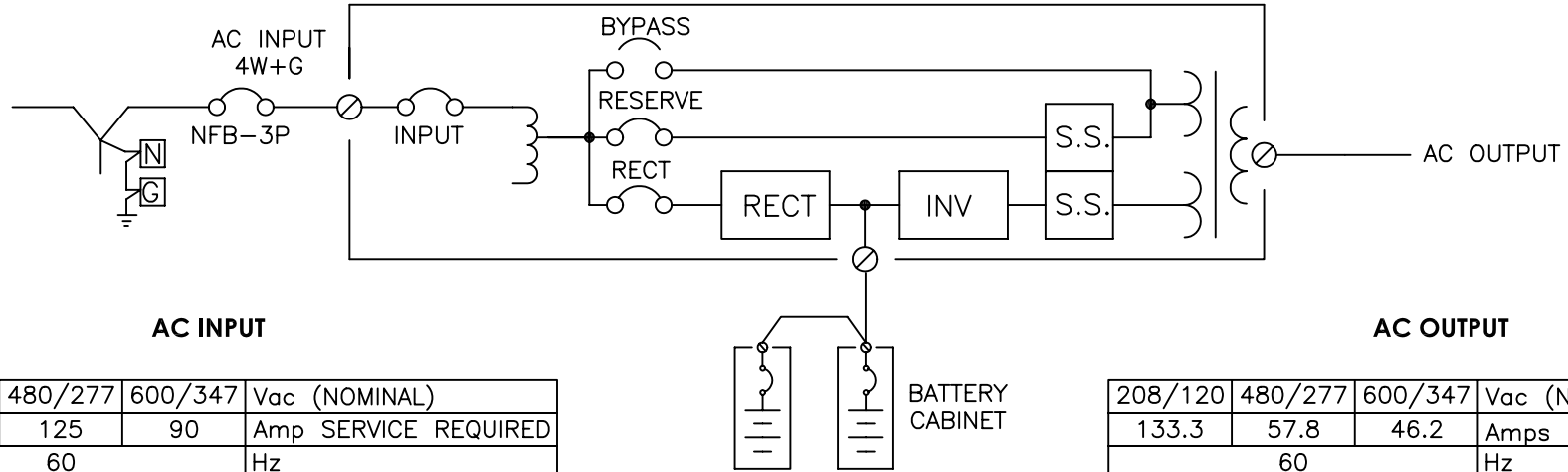

#### AC INPUT

208/120	480/277	600/347	Vac (NOMINAL)
250	125	90	Amp SERVICE REQUIRED
			60 Hz
			3 PHASE
			4 WIRE PLUS GROUND

#### AC OUTPUT

208/120	480/277	600/347	Vac (NOMINAL)
133.3	57.8	46.2	Amps (MAXIMUM)
			60 Hz
			3 PHASE
			4 WIRE PLUS GROUND

#### BATTERY DATA

BATTERIES: Always On  
 TYPE: VRLA  
 RUN TIME: 30, 60 MINUTES

#### BTU RATING

BTU 14025  
 KW 4.17

#### STANDARD

SNMP  
 F.A. CONTACTS  
 AS400 CARD

<b>Always On UPS Systems Inc.</b>		Kelowna B.C. alwayson.com PH:877-259-2976
BOREALIS 48KW SINGLE LINE 30/60 MINUTE BBU		Reproduction and/or use without express permission is prohibited by law.
FILE: BOREALIS 48KW 30_60MIN	VERSION: 1.0	DRAWN BY: HL
PAGE: 1/2	DATE: 080724	PROJECT: BOREALIS
		DESIGNED BY: AA

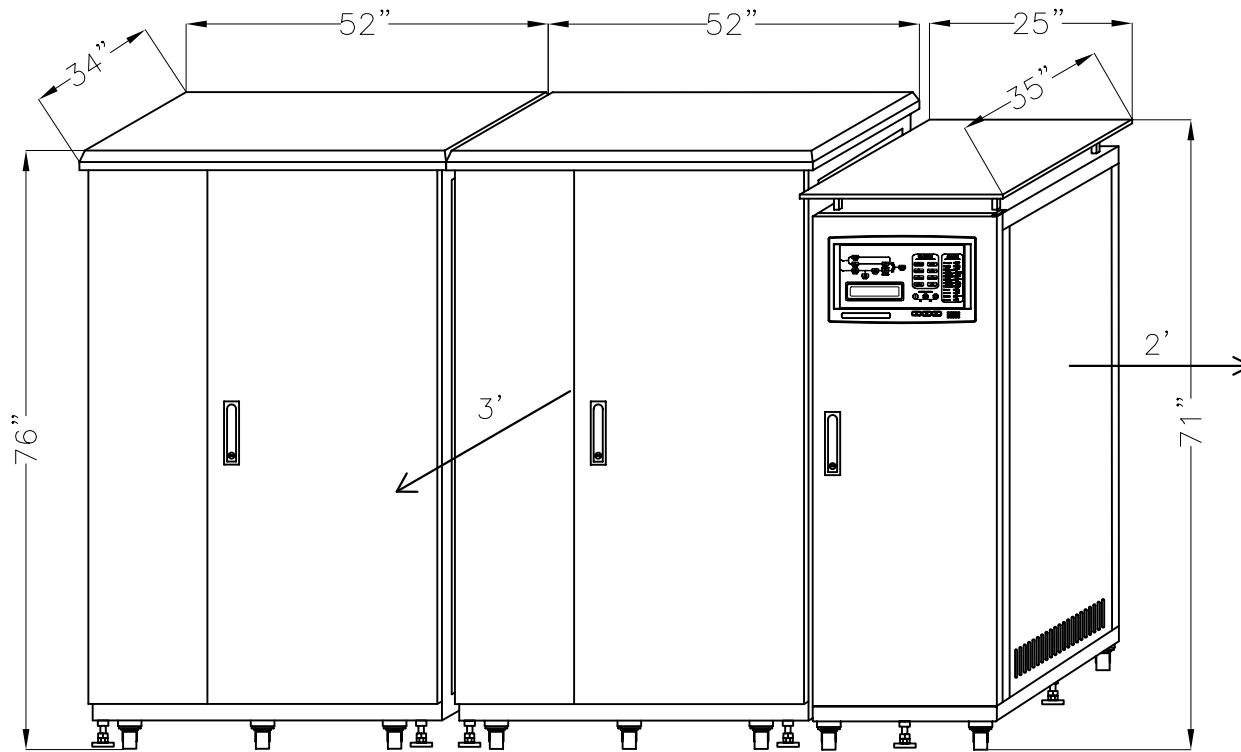

BATTERY CABINET  
52"X34"X76"

BATTERY CABINET  
52"X34"X76"

ELI CABINET WITH DRIP SHIELD  
25"X35"X71"

**WEIGHT**

ELI CABINET 1874LBS / 850KG

BATTERY CABINET 2X (LBS/KG)

30MIN	60MIN
3083/1398	3890/1764

**STANDARD**

DRIP SHIELD

**Always On UPS Systems Inc.**

Kelowna B.C.  
alwayson.com  
PH:877-259-2976

BOREALIS 48KW DIMENSION  
30/60 MINUTE BBU

Reproduction and/or  
use without express  
permission is  
prohibited by law.

FILE: BOREALIS 48KW 30\_60MIN

VERSION: 1.0

DRAWN BY: HL

PAGE: 2/2

DATE: 080724

PROJECT: BOREALIS

DESIGNED BY: AA